

# MARINE CABLES WITH ALUMINIUM CONDUCTORS

LIGHTER VESSELS  
LOWER COSTS  
HIGHER PROFITABILITY



**HELKAMA**

THE PERFECT CONNECTION

# A reel thing.

With a new twist.



Helkama specializes in the development and production of marine and offshore cables with experience in this field going back over fifty years. Our high technical quality has been achieved by continuous development work together with our clients. In this catalogue we proudly present our newest development – Fine stranded, Aluminium conductor power cables.

We have chosen to produce power cables with fine stranded aluminium conductors as a new lightweight and cost-effective alternative to traditional copper conductor power cables. This has become possible as DNV-GL has approved the use of aluminium conductors in shipboard use. This construction of aluminium cables has previously been used in aviation and automotive industries, industries where weight reduction and thereby fuel efficiency are of outmost importance without making compromises in safety.

Copper has been the preferred electrical conductor, but the price of copper has been rising sharply over the last several decades, putting added cost pressure on the marine industry. The demand for big-size power cables has also increased with the development of electrical propulsion and the broader electrification of ships.

Due to aluminium's lower conductivity a thicker cable is needed, but this is compensated by an overall lighter weight, resulting in a 50% lower cable weight compared to traditional copper cables. This results in lighter vessels, increasing fuel efficiency for smaller vessels by lowering operating costs, and creating higher profitability in operation for heavier ships by added cargo.

Another substantial benefit is the significantly lower price of aluminium over copper. Even with the bigger conductor size and higher manufacturing and terminations costs, the total cost of the aluminium conductor power cable is lower than the traditional copper cable – reducing some of the price pressure on the shipbuilding industry.

The rest of the properties in these new cables are of the same high Helkama quality customers have become accustomed to. Our short delivery times backed up by extensive stocks enable us to deliver punctually. And to top all of this off we offer exquisite customer service with our sales team ready to help with Your project from the design phase all the way to the cables arriving on time on-site.

When it comes to marine cables, we are the reel deal.



## **KLAUKE - 140 years of experience in connection technology and with tools**

All over the world, Klauke is renowned for its highquality electrical connection technology and tools for crimping, cutting and punching. Klauke offers special-purpose solutions for connection technology and tools to meet requirements in the most diverse sectors.

## **Contents**

<b>ALUMINIUM CONDUCTOR CABLES</b>	
LKM-ALU.....	4
LKSM-ALU.....	6
LKSM-EMC-ALU.....	8
LKSM-VFD-ALU.....	10
<b>CABLE LUGS</b> .....	12
<b>INSTALLATION</b> .....	13
<b>KLAUKE TECHNICAL INFORMATION</b> .....	14
<b>TYPE APPROVAL CERTIFICATES</b> .....	15
<b>HELKAMA TECHNICAL INFORMATION</b> .....	16



# LKM-ALU

Unarmoured power and control cable 0.6/1 kV

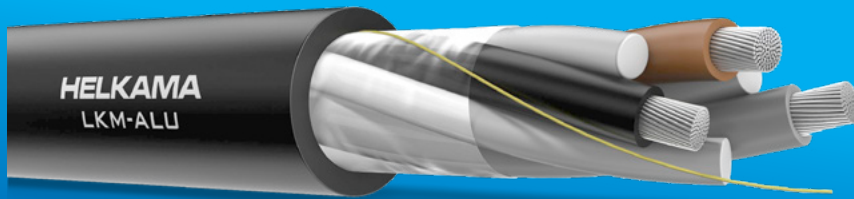

- Flame-retardant • Halogen-free • Low smoke emission • Oil resistant (only SHF2)

<b>CONDUCTOR</b>	Stranded aluminium conductor 35-185 mm <sup>2</sup>	IEC 60228, class 2 fine stranded
<b>INSULATION</b>	XLPE	IEC 60092-360
<b>CABLING/BEDDING</b>	Cabling with optional fillers or dummy cores to obtain symmetrical and round construction	
<b>SHEATH</b>	Polyolefine plastic, SHF1 On request, thermosetting polyolefine, SHF2 Standard colour black, other colours on request	IEC 60092-360
<b>REFERENCE STANDARDS</b>	IEC 60092-353, design	

## APPLICATION

For fixed installation in most areas and on open deck in ships and offshore units.

## MAIN CHARACTERISTICS:

<b>FIRE PERFORMANCE</b>	IEC 60332-1-2 IEC 60332-3-22
<b>RATED VOLTAGE</b>	AC 0.6/1 kV (1.2 kV) DC 0.9/1.5 kV (if voltage to earth does not exceed 0.9 kV)
<b>HALOGEN-FREE</b>	IEC 60754 series
<b>SMOKE EMISSION</b>	IEC 61034 series
<b>OIL RESISTANCE (ONLY SHF2)</b>	IEC 60811-404 conditions according to 60092-360/SHF2
<b>MIN. INSTALLATION TEMPERATURE</b>	-15 °C
<b>OPERATING TEMPERATURE</b>	-40 - 80 °C
<b>MAX. CONDUCTOR TEMPERATURE</b>	90 °C

Subject to change without prior notice. See latest update on our webpage.

© 2022 Helkama Bica Oy. All rights reserved.

## LKM-ALU 0.6/1 kV

Part number		Number of conductors & cross-section n x mm <sup>2</sup>	Nominal outer Ø mm	Weight kg/km	Current rating A	Min. bending radius fixed installation mm
<b>Normal</b>	<b>G-type</b>					
2820114010	---	1 x 35 mm <sup>2</sup>	12.0	195	119	50
2820115010	---	1 x 50 mm <sup>2</sup>	13.5	245	149	55
2820116010	---	1 x 70 mm <sup>2</sup>	15.5	335	184	65
2820117010	---	1 x 95 mm <sup>2</sup>	17.5	430	223	70
2820118010	---	1 x 120 mm <sup>2</sup>	19.0	525	258	80
2820119010	---	1 x 150 mm <sup>2</sup>	21.5	665	296	90
2820120010	---	1 x 185 mm <sup>2</sup>	24.0	815	337	100
2820114020	---	2 x 35 mm <sup>2</sup>	22.0	620	102	90
2820115020	---	2 x 50 mm <sup>2</sup>	25.0	785	127	150
2820116020	---	2 x 70 mm <sup>2</sup>	29.0	1080	157	180
2820117020	---	2 x 95 mm <sup>2</sup>	33.5	1425	189	200
2820118020	---	2 x 120 mm <sup>2</sup>	36.5	1730	219	225
2820119020	---	2 x 150 mm <sup>2</sup>	41.0	2180	252	250
2820120020	---	2 x 185 mm <sup>2</sup>	47.0	2775	287	285
2820114030	2820114031	3 x 35 mm <sup>2</sup>	23.5	725	83	95
2820115030	2820115031	3 x 50 mm <sup>2</sup>	27.0	930	104	165
2820116030	2820116031	3 x 70 mm <sup>2</sup>	31.5	1295	128	190
2820117030	2820117031	3 x 95 mm <sup>2</sup>	35.5	1680	156	215
2820118030	2820118031	3 x 120 mm <sup>2</sup>	39.5	2085	180	240
2820119030	2820119031	3 x 150 mm <sup>2</sup>	44.5	2595	207	270
2820120030	2820120031	3 x 185 mm <sup>2</sup>	50.5	3295	236	305
2820114040	2820114041	4 x 35 mm <sup>2</sup>	26.5	905	83	160
2820115040	2820115041	4 x 50 mm <sup>2</sup>	30.0	1170	104	185
2820116040	2820116041	4 x 70 mm <sup>2</sup>	35.0	1615	128	215
2820117040	2820117041	4 x 95 mm <sup>2</sup>	40.0	2135	156	240
2820118040	2820118041	4 x 120 mm <sup>2</sup>	44.0	2590	180	265
2820119040	2820119041	4 x 150 mm <sup>2</sup>	49.5	3285	207	300
2820120040	2820120041	4 x 185 mm <sup>2</sup>	56.0	4155	236	340
2820114050	2820114051	5 x 35 mm <sup>2</sup>	29.0	1105	69	175
2820115050	2820115051	5 x 50 mm <sup>2</sup>	33.0	1435	86	200
2820116050	2820116051	5 x 70 mm <sup>2</sup>	39.0	2035	107	240
2820117050	2820117051	5 x 95 mm <sup>2</sup>	44.0	2645	129	265
2820118050	2820118051	5 x 120 mm <sup>2</sup>	49.0	3280	150	295
2820119050	2820119051	5 x 150 mm <sup>2</sup>	55.0	4185	172	335
2820120050	2820120051	5 x 185 mm <sup>2</sup>	62.5	5330	195	380

# LKSM-ALU

Armoured power and control cable 0.6/1 kV

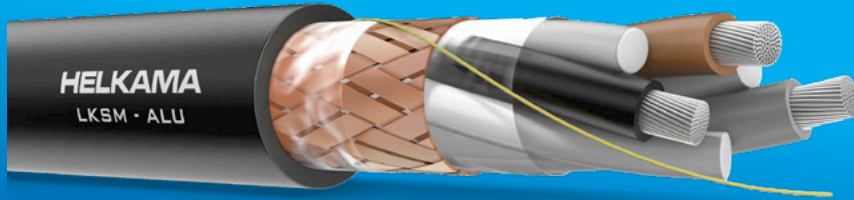

• Flame-retardant • Halogen-free • Low smoke emission • Oil resistant (only SHF2)

<b>CONDUCTOR</b>	Stranded aluminium conductor 35-185 mm <sup>2</sup>	IEC 60228, class 2 fine stranded
<b>INSULATION</b>	XLPE	IEC 60092-360
<b>CABLING/BEDDING</b>	Cabling with optional fillers or dummy cores to obtain symmetrical and round construction	
<b>ARMOUR</b>	Copper wire braid, coverage > 90% Tinned copper wire braid on request	IEC 60092-350
<b>SHEATH</b>	Polyolefine plastic, SHF1 On request, thermosetting polyolefine, SHF2 Standard colour black, other colours on request	IEC 60092-360
<b>REFERENCE STANDARDS</b>	IEC 60092-353, design	

## APPLICATION

For fixed installation in most areas and on open deck in ships and offshore units.

## MAIN CHARACTERISTICS:

<b>FIRE PERFORMANCE</b>	IEC 60332-1-2 IEC 60332-3-22
<b>RATED VOLTAGE</b>	AC 0.6/1 kV (1.2 kV) DC 0.9/1.5 kV (if voltage to earth does not exceed 0.9 kV)
<b>HALOGEN-FREE</b>	IEC 60754 series
<b>SMOKE EMISSION</b>	IEC 61034 series
<b>OIL RESISTANCE (ONLY SHF2)</b>	IEC 60811-404 conditions according to 60092-360/SHF2
<b>MIN. INSTALLATION TEMPERATURE</b>	-15 °C
<b>OPERATING TEMPERATURE</b>	-40 - 80 °C
<b>MAX. CONDUCTOR TEMPERATURE</b>	90 °C

Subject to change without prior notice. See latest update on our webpage.

© 2022 Helkama Bica Oy. All rights reserved.

## LKSM-ALU 0.6/1 kV

Part number		Number of conductors & cross-section n x mm <sup>2</sup>	Cross-section of armour mm <sup>2</sup>	Nominal outer Ø mm	Weight kg/km	Current rating A	Min. bending radius fixed installation mm
Normal	G-type						
2830214010	---	1 x 35 mm <sup>2</sup>	4.6	14.5	265	119	90
2830215010	---	1 x 50 mm <sup>2</sup>	10.1	17.0	395	149	105
2830216010	---	1 x 70 mm <sup>2</sup>	10.2	19.5	480	184	120
2830217010	---	1 x 95 mm <sup>2</sup>	10.5	21.0	590	223	130
2830218010	---	1 x 120 mm <sup>2</sup>	12.9	23.5	725	258	145
2830219010	---	1 x 150 mm <sup>2</sup>	13.1	26.0	870	296	160
2830220010	---	1 x 185 mm <sup>2</sup>	15.9	29.0	1055	337	180
2830214020	---	2 x 35 mm <sup>2</sup>	13.2	26.0	965	102	160
2830215020	---	2 x 50 mm <sup>2</sup>	16.1	30.0	1330	127	180
2830216020	---	2 x 70 mm <sup>2</sup>	17.7	35.0	1700	157	215
2830217020	---	2 x 95 mm <sup>2</sup>	20.0	38.5	2140	189	230
2830218020	---	2 x 120 mm <sup>2</sup>	35.6	43.5	2840	219	265
2830219020	---	2 x 150 mm <sup>2</sup>	36.9	49.0	3565	252	295
2830220020	---	2 x 185 mm <sup>2</sup>	39.5	55.5	4430	287	335
2830214030	2830214031	3 x 35 mm <sup>2</sup>	15.9	27.5	1020	83	170
2830215030	2830215031	3 x 50 mm <sup>2</sup>	16.5	32.0	1350	104	195
2830216030	2830216031	3 x 70 mm <sup>2</sup>	19.0	37.5	1825	128	230
2830217030	2830217031	3 x 95 mm <sup>2</sup>	21.5	41.0	2340	156	250
2830218030	2830218031	3 x 120 mm <sup>2</sup>	36.4	46.5	2945	180	280
2830219030	2830219031	3 x 150 mm <sup>2</sup>	38.4	53.0	3685	207	320
2830220030	2830220031	3 x 185 mm <sup>2</sup>	42.5	59.5	4535	236	360
2830214040	2830214041	4 x 35 mm <sup>2</sup>	16.2	30.5	1170	83	185
2830215040	2830215041	4 x 50 mm <sup>2</sup>	18.4	35.5	1595	104	215
2830216040	2830216041	4 x 70 mm <sup>2</sup>	21.2	41.5	2110	128	250
2830217040	2830217041	4 x 95 mm <sup>2</sup>	36.4	46.0	2790	156	280
2830218040	2830218041	4 x 120 mm <sup>2</sup>	38.3	51.5	3370	180	315
2830219040	2830219041	4 x 150 mm <sup>2</sup>	43.2	59.0	4285	207	355
2830220040	2830220041	4 x 185 mm <sup>2</sup>	48.1	66.0	5280	236	400
2830214050	2830214051	5 x 35 mm <sup>2</sup>	17.5	33.5	1375	69	205
2830215050	2830215051	5 x 50 mm <sup>2</sup>	20.5	39.0	1855	86	235
2830216050	2830216051	5 x 70 mm <sup>2</sup>	36.2	46.5	2620	107	280
2830217050	2830217051	5 x 95 mm <sup>2</sup>	38.2	51.0	3265	129	310
2830218050	2830218051	5 x 120 mm <sup>2</sup>	42.5	57.5	4010	150	345
2830219050	2830219051	5 x 150 mm <sup>2</sup>	48.1	65.0	5135	172	395

# LKSM-EMC-ALU

Armoured power and control cable  
with improved EMC screening 0.6/1 kV

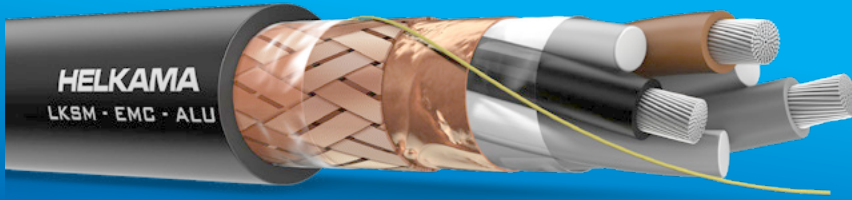

• Flame-retardant • Halogen-free • Low smoke emission • Oil resistant (only SHF2)

<b>CONDUCTOR</b>	Stranded aluminium conductor 35-185 mm <sup>2</sup>	IEC 60228, class 2 fine stranded
<b>INSULATION</b>	XLPE	IEC 60092-360
<b>CABLING/BEDDING</b>	Cabling with optional fillers or dummy cores to obtain symmetrical and round construction	
<b>SCREEN</b>	Copper tape, coverage 100%	
<b>ARMOUR</b>	Copper wire braid, coverage > 90% Tinned copper wire braid on request	IEC 60092-350
<b>SHEATH</b>	Polyolefine plastic, SHF1 On request, thermosetting polyolefine, SHF2 Standard colour black, other colours on request	IEC 60092-360
<b>REFERENCE STANDARDS</b>	IEC 60092-353, design	

## APPLICATION

For fixed installation in most areas and on open deck in ships and offshore units. Specially designed cables, with screen which has improved screening properties to address EMI/EMC problems.

## MAIN CHARACTERISTICS:

<b>FIRE PERFORMANCE</b>	IEC 60332-1-2 IEC 60332-3-22
<b>RATED VOLTAGE</b>	AC 0.6/1 kV (1.2 kV) DC 0.9/1.5 kV (if voltage to earth does not exceed 0.9 kV)
<b>HALOGEN-FREE</b>	IEC 60754 series
<b>SMOKE EMISSION</b>	IEC 61034 series
<b>OIL RESISTANCE (ONLY SHF2)</b>	IEC 60811-404 conditions according to 60092-360/SHF2
<b>TRANSFER IMPEDANCE</b>	IEC 61196-1 (typical value 26 dB over 1 mΩ/m at 100 MHz [20 mΩ/m])
<b>MIN. INSTALLATION TEMPERATURE</b>	-15 °C
<b>OPERATING TEMPERATURE</b>	-40 - 80 °C
<b>MAX. CONDUCTOR TEMPERATURE</b>	90 °C

Subject to change without prior notice. See latest update on our webpage.

© 2022 Helkama Bica Oy. All rights reserved.



## LKSM-EMC-ALU 0.6/1 kV

Part number		Number of conductors & cross-section n x mm <sup>2</sup>	Cross-section of armour mm <sup>2</sup>	Nominal outer Ø mm	Weight kg/km	Current rating A	Min. bending radius fixed installation mm
Normal	G-type						
2840214010	---	1 x 35 mm <sup>2</sup>	4.6	14.5	320	119	115
2840215010	---	1 x 50 mm <sup>2</sup>	10.1	17.0	450	149	135
2840216010	---	1 x 70 mm <sup>2</sup>	10.2	19.5	555	184	155
2840217010	---	1 x 95 mm <sup>2</sup>	10.6	21.0	660	223	170
2840218010	---	1 x 120 mm <sup>2</sup>	13.0	23.5	805	258	190
2840219010	---	1 x 150 mm <sup>2</sup>	13.1	26.5	975	296	210
2840220010	---	1 x 185 mm <sup>2</sup>	16.0	29.5	1165	337	235
2840214020	---	2 x 35 mm <sup>2</sup>	13.5	26.0	1055	102	210
2840215020	---	2 x 50 mm <sup>2</sup>	16.2	30.0	1390	127	240
2840216020	---	2 x 70 mm <sup>2</sup>	18.0	35.0	1830	157	280
2840217020	---	2 x 95 mm <sup>2</sup>	20.3	38.5	2305	189	310
2840218020	---	2 x 120 mm <sup>2</sup>	35.7	43.5	2950	219	350
2840219020	---	2 x 150 mm <sup>2</sup>	37.0	49.0	3705	252	395
2840220020	---	2 x 185 mm <sup>2</sup>	40.0	55.5	4530	287	445
2840214030	2840214031	3 x 35 mm <sup>2</sup>	16.0	27.5	1115	83	220
2840215030	2840215031	3 x 50 mm <sup>2</sup>	16.8	32.5	1500	104	260
2840216030	2840216031	3 x 70 mm <sup>2</sup>	19.3	37.5	1970	128	300
2840217030	2840217031	3 x 95 mm <sup>2</sup>	21.8	41.0	2435	156	330
2840218030	2840218031	3 x 120 mm <sup>2</sup>	36.6	46.5	3125	180	375
2840219030	2840219031	3 x 150 mm <sup>2</sup>	38.8	53.0	3920	207	425
2840220030	2840220031	3 x 185 mm <sup>2</sup>	42.9	59.5	4775	236	475
2840214040	2840214041	4 x 35 mm <sup>2</sup>	16.2	30.5	1220	83	245
2840215040	2840215041	4 x 50 mm <sup>2</sup>	18.7	35.5	1650	104	285
2840216040	2840216041	4 x 70 mm <sup>2</sup>	21.5	41.5	2145	128	335
2840217040	2840217041	4 x 95 mm <sup>2</sup>	36.6	46.5	2820	156	370
2840218040	2840218041	4 x 120 mm <sup>2</sup>	38.8	52.0	3420	180	415
2840219040	2840219041	4 x 150 mm <sup>2</sup>	43.3	59.0	4285	207	470
2840220040	2840220041	4 x 185 mm <sup>2</sup>	47.8	66.5	5240	236	530
2840214050	2840214051	5 x 35 mm <sup>2</sup>	17.8	33.5	1480	69	270
2840215050	2840215051	5 x 50 mm <sup>2</sup>	20.7	39.0	1980	86	315
2840216050	2840216051	5 x 70 mm <sup>2</sup>	36.4	46.5	2750	107	375
2840217050	2840217051	5 x 95 mm <sup>2</sup>	38.6	51.0	3435	129	410
2840218050	2840218051	5 x 120 mm <sup>2</sup>	43.0	57.5	4190	150	460
2840219050	2840219051	5 x 150 mm <sup>2</sup>	48.2	65.5	5335	172	525

# LKSM-VFD-ALU

Armoured power and control cable  
with improved EMC screening 1.8/3 kV



• Flame-retardant • Halogen-free • Low smoke emission • Oil resistant (only SHF2)

<b>CONDUCTOR</b>	Stranded aluminium conductor 35-185 mm <sup>2</sup>	IEC 60228, class 2 fine stranded
<b>INSULATION</b>	XLPE	IEC 60092-360
<b>CABLING/BEDDING</b>	Cabling with optional fillers or dummy cores to obtain symmetrical and round construction	
<b>SCREEN</b>	Copper tape, coverage 100%	
<b>ARMOUR</b>	Copper wire braid, coverage > 90% Tinned copper wire braid on request	IEC 60092-350
<b>SHEATH</b>	Polyolefine plastic, SHF1 On request, thermosetting polyolefine, SHF2 Standard colour black, other colours on request	IEC 60092-360
<b>REFERENCE STANDARDS</b>	IEC 60092-353, design	

## APPLICATION

For fixed installation in most areas and on open deck in ships and offshore units. Design to meet requirements for Variable Frequency Drivers (VFD). Suitable for voltage peaks up to 3 kV.

## MAIN CHARACTERISTICS:

<b>FIRE PERFORMANCE</b>	IEC 60332-1-2 IEC 60332-3-22
<b>RATED VOLTAGE</b>	1.8/3 kV (3.6 kV)
<b>HALOGEN-FREE</b>	IEC 60754 series
<b>SMOKE EMISSION</b>	IEC 61034 series
<b>OIL RESISTANCE (ONLY SHF2)</b>	IEC 60811-404 conditions according to 60092-360/SHF2
<b>TRANSFER IMPEDANCE</b>	IEC 61196-1 (typical value 26 dB over 1 mΩ/m at 100 MHz [≥20 mΩ/m])
<b>MIN. INSTALLATION TEMPERATURE</b>	-15 °C
<b>OPERATING TEMPERATURE</b>	-40 - 80 °C
<b>MAX. CONDUCTOR TEMPERATURE</b>	90 °C

Subject to change without prior notice. See latest update on our webpage.

© 2022 Helkama Bica Oy. All rights reserved.

## LKSM-VFD-ALU 1.8/3 kV

Part number	Number of conductors & cross-section n x mm <sup>2</sup>	Cross-section of armour mm <sup>2</sup>	Nominal outer Ø mm	Weight kg/km	Current rating A	Min. bending radius fixed installation mm
<b>Normal</b> ---						
2850214010 ---	1 x 35 mm <sup>2</sup>	8.7	17.5	430	119	140
2850215010 ---	1 x 50 mm <sup>2</sup>	9.6	19.5	515	149	155
2850216010 ---	1 x 70mm <sup>2</sup>	10.6	21.5	610	184	170
2850217010 ---	1 x 95mm <sup>2</sup>	11.9	23.0	745	223	185
2850218010 ---	1 x 120mm <sup>2</sup>	12.8	25.0	840	258	200
2850219010 ---	1 x 150mm <sup>2</sup>	14.0	27.5	1010	296	220
2850220010 ---	1 x 185mm <sup>2</sup>	14.8	29.5	1150	337	235
2850214030 ---	3 x 35mm <sup>2</sup>	17.7	33.0	1450	83	265
2850215030 ---	3 x 50mm <sup>2</sup>	19.8	37.5	1840	104	300
2850216030 ---	3 x 70mm <sup>2</sup>	21.8	42.5	2325	128	340
2850217030 ---	3 x 95mm <sup>2</sup>	35.1	45.5	2930	156	365
2850218030 ---	3 x 120mm <sup>2</sup>	37.8	50.0	3460	180	400
2850219030 ---	3 x 150mm <sup>2</sup>	41.0	55.0	4120	207	440
2850220030 ---	3 x 185mm <sup>2</sup>	44.4	60.0	4835	236	480
2850220035 ---	3 x 185+3 x 35 mm <sup>2</sup>	44.4	60.0	4570	236	480

## Electrical connection systems

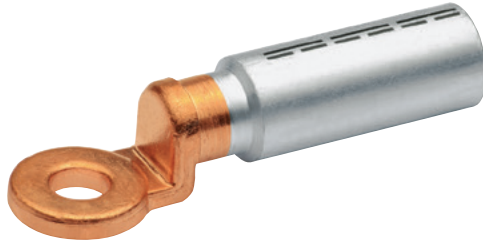

### Bimetallic cable lugs Al/Cu 35-185mm<sup>2</sup> Helkama ALU Marine cables

- For connecting Aluminium cables to Copper terminations
- Also compatible with solid and multi stranded conductors according to IEC 60228

### High quality design

- Tube dimension to DIN 46329
- Filled with a contact grease to break the corrosion layer of the Aluminum conductor and seal the connection
- Internal chamfer for simple cable insertion
- Barrier design with oil stop and solid copper palm
- With crimp markings for correct crimp positioning
- Prohibits galvanic corrosion between copper and aluminum
- Material/Surface: E-Al, Copper acc. to EN 13600/bright

Helkama ALU Marine cable	Cable lug part. no.	Bolt hole Ø $xx$ in mm	Cable lug code printed on lug	Dimension $a$ in mm	Number of crimps Klauke EKM60ID
35 mm <sup>2</sup>	366R $xx$	8; 10; 12	$xx$ -KL16 50°rm/70°se	43	2
50 mm <sup>2</sup>	367R $xx$	8; 10; 12	$xx$ -KL18 70°rm/95°se	51	3
70 mm <sup>2</sup>	368R $xx$	8; 10; 12; 16	$xx$ -KL22 95°rm/120°se	56	3
95 mm <sup>2</sup>	369R $xx$	8; 12; 16	$xx$ - <b>KL22 120°rm/150°se</b>	56	3
120 mm <sup>2</sup>	370R $xx$	12; 16	$xx$ -KL25 150°rm/185°se	62	3
150 mm <sup>2</sup>	371R $xx$	10; 12; 16; 20	$xx$ -KL28 185°rm/240°se	62	3
185 mm <sup>2</sup>	372R $xx$	10; 12; 16; 20	$xx$ -KL32 240°rm/300°se	72	3

E.g.: 16-KL22 120°rm/150°se

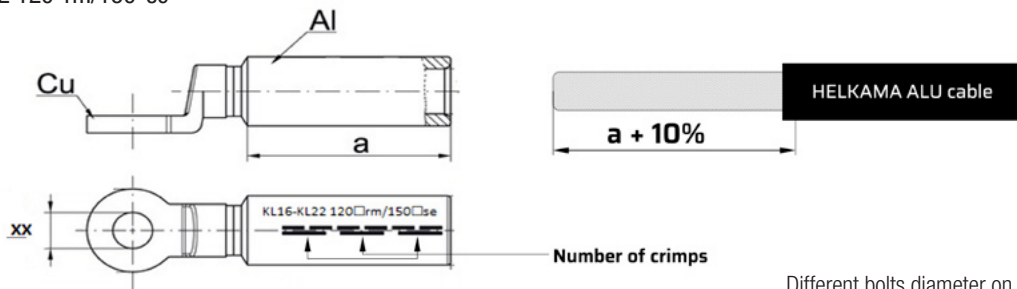

Different bolts diameter on request (M6-M20)

**DNV-GL approved only in combination with crimping tool EKM60ID**

## Crimping tools

# One tool for all applications

**EKM 60 ID Battery powered hydraulic crimping tool 10 - 240 mm<sup>2</sup>**

**NEXT GENERATION**



- ▶ Extra large crimping area due to innovative 2-stage telescopic cylinder
- ▶ Indent crimping - no changing of dies required
- ▶ All tool data in view thanks to display and i-press® app

**Characteristics**

- Choose your battery system: Bosch or Makita
- All data can be easily read via Bluetooth
- With innovative 2-stage telescopic cylinder
- Closed head, flip top style, rotatable
- Quality assurance via visual and audible signals in case of error
- Simple and safe: One-button operating concept for controlling all tool functions
- Effortless working due to balanced centre of gravity
- LED for work area illumination
- Always ready-to-use thanks to battery charge and service display

**Suitable for**

- Very well suited for compacted conductors
- Especially for fine strand conductors to IEC 60228
- Certified from 16 mm<sup>2</sup> onwards



Suitable for	Connection material	Crimping range mm <sup>2</sup>	Crimp profile
<b>Copper tubular cable lugs and connectors</b>			
Tubular cable lugs and connectors, standard type, Tubular cable lugs for switch gear connections		10 - 240	
Tubular cable lugs and connectors for fine stranded conductors		10 - 240	
<b>Terminals, connectors and pin terminals acc. to DIN</b>			
Solderless terminals (DIN 46234) connectors and pin terminals (DIN 46230, DIN 46341)		10 - 240	
<b>Aluminum/copper compression cable lugs and connectors</b>			
Compression cable lugs and connectors according to DIN - Al and Al/Cu		50-240	
Compression cable lugs and connectors according to Al/Cu (Helkama ALU Marine cables)		35 - 185	

*Verbindungen mit System*  
*The POWER of Partnership*

Thousands of electricians use Klauke cable lugs and tools every day, to ensure reliable connections and increased safety on the jobsite.

## Cutting tool

# Cuts Whatever Fits!

**ESM 50 Battery powered hydraulic cutting tool 50 mm dia. for copper and aluminium cable**

**NEXT GENERATION**



- ▶ For cutting copper and aluminium cables (fine-stranded also)
- ▶ Very high cutting capacity thanks to innovative cutting geometry
- ▶ All tool data in view thanks to display and i-press® app

**Characteristics**

- Choose your battery system: Bosch or Makita
- All data can be easily read via Bluetooth
- Open head, rotatable
- Simple and safe: One-button operating concept for controlling all tool functions
- Effortless working due to balanced centre of gravity
- LED for work area illumination
- Simple and safe: Automatic retraction when operation is complete
- Manual retract stop (MRS) for efficient operations
- Always ready-to-use thanks to battery charge and service display

**Suitable for**

- Cu and Al cables (multi and fine stranded) even armoured cable

Many more crimping and cutting tools for different applications you can find at **Klauke.com**

## Electrical connection systems

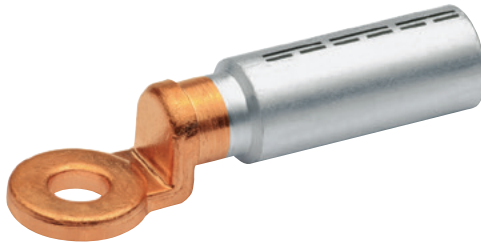

### Bimetallic cable lugs Al/Cu

#### 35-185mm<sup>2</sup> Helkama ALU Marine cables

- For connecting Aluminium cables to Copper terminations
- Also compatible with solid and multi stranded conductors according to IEC 60228

#### High quality design

- Tube dimension to DIN 46329
- Filled with a contact grease to break the corrosion layer of the Aluminum conductor and seal the connection
- Internal chamfer for simple cable insertion
- Barrier design with oil stop and solid copper palm
- With crimp markings for correct crimp positioning
- Prohibits galvanic corrosion between copper and aluminum
- Material/Surface: E-Al, Copper acc. to EN 13600/bright

mm <sup>2</sup> Helkama ALU Marine cables	mm <sup>2</sup> Multi stranded round- and sector-shaped	mm <sup>2</sup> Single round- and sector-shaped	M8	M10	M12	M16	M20
35	50	70	366R8	366R10	366R12		
50	70	95		367R10	367R12		
70	95	120		368R10	368R12	368R16	
95	120	150	369R8	369R10	369R12	369R16	
120	150	185	370R8	370R10	370R12	370R16	370R20
150	185	240	371R8	371R10	371R12	371R16	371R20
185	240	300		372R10	372R12	372R16	372R20

Different bolts diameter on request (M6-M20)

## Verbindungen mit *System* The *POWER* of Partnership

Thousands of electricians use Klauke cable lugs and tools every day, to ensure reliable connections and increased safety on the jobsite.



# TYPE APPROVAL CERTIFICATES

Helkama cables with aluminium conductors shall be terminated with KLAUKE Alu/Cu bimetallic compression cable lugs for aluminium conductors sizes 35, 50, 70, 95, 120, 150, 185 mm<sup>2</sup>, type approved according to DNV rules DNVGL-CP-0409.

For other classification societies, no current approvals due to their rules pending update to accept the use of aluminium conductors in Marine power cables.

Copies of the Type Approval Certificates downloadable on HELKAMA webpage.

Cable types	Helkama Cables	Klauke Lugs
LKM-ALU	DNV TAE000047D	DNV TAE00004DV
LKM-ALU-SF2		
LKSM-ALU	DNV TAE000047F	
LKSM-ALU-SHF2		
LKSM-EMC-ALU		
LKSM-EMC-ALU-SHF2		
LKSM-VFD-ALU		
LKSM-VFD-ALU-SHF2		



# GENERAL INFORMATION

## MATERIALS

### CONDUCTOR MATERIAL

#### ALU

Annealed Aluminium, fine stranded, similar to IEC 60228 class5 copper conductors. Resistance according to IEC 60228 stranded aluminium.

### INSULATION MATERIALS

#### XLPE

Cross-linked polyethylene compound. Excellent mechanical and electrical characteristics

### SHEATHING MATERIALS

#### SHF1

LSZH thermoplastic. Low smoke zero halogen thermoplastic compound. Flame retardant and self-extinguishing in the event of fire.

#### SHF2

Crosslinked thermoset plastic. Low smoke zero halogen cross-linked thermoset oil-resistant compound. Flame retardant and self-extinguishing in the event of fire.

### MARKING ON THE SHEATH

Lot number, Cable type, Cable size (number of cores x size of conductors mm<sup>2</sup>), Voltage, Temperature, Standards, Manufacturer's name, Production month and year, Meter marking.

### NOTE!

Cables that are cut and stored, the cable ends must be sealed with moisture-proof end caps. E.g. Heat shrink end caps with glue inside.

## TESTS AND DEFINITIONS OF TERMS

### HALOGEN-FREE

Halogen-free refers to the absence of halogens, such as chlorine and fluorine. Determined on the basis of the halogen content and the acidity of cable's gases.

Halogen-free IEC 60754-series consists of standards IEC 60754-1 and IEC 60754-2.

#### IEC 60754-1

Determines halogen content of material. Halogen content of material may not exceed 0.5% or 5 mg/g.

#### IEC 60754-2

Determines degree of acidity of combustion gases. Limit values > 4.3 for pH and < 10 µS/mm for conductivity.

### SMOKE EMISSION

#### IEC 61034-1, IEC 61034-2

Smoke emission refers to visibility in a fire. Greater light transmittance means better visibility. Smoke Emission IEC 61034-series consists of standards IEC 61034-1 and IEC 61034-2.

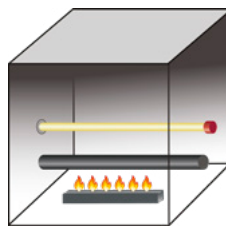

**27 m<sup>3</sup> cube  
smoke chamber**

*Requirements: 60% light transmittance*



## FIRE PERFORMANCE

### IEC 60332-1, IEC 60332-3

Cables must withstand the test specified in IEC standard 60332-3 or IEC 60332-1. Flame-retardant cables do not propagate fire and are self-extinguishing.

### IEC 60332-1

Test for single cable. Test procedure and requirements according to picture below.

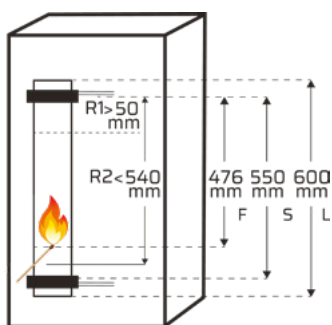

*Min. 50 mm of the cable, measured from the upper support, must remain unburned after the specified time.*

### IEC 60332-3

Test for bunched cables with three categories - A, B and C. Categories are defined by different limits for flammable material and burning times. Cables must extinguish themselves once the burner has been removed.

Test procedure and requirements according to picture below.

All Helkama cables comply with the most severe category - A. Requirements according to IEC 60332-3-22. Amount of burning material is 7 litres/m and burning time 40 minutes.

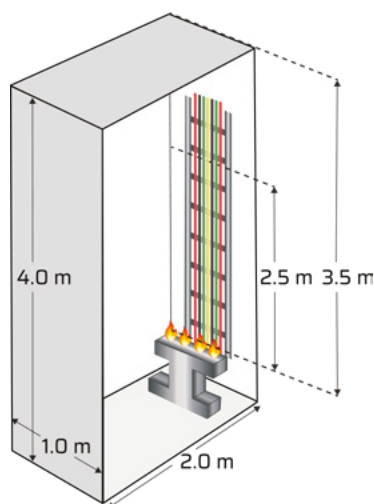

*Burning allowed up to max. 2.5 meters from the burner within a specified time.*

## BENDING RADIUS

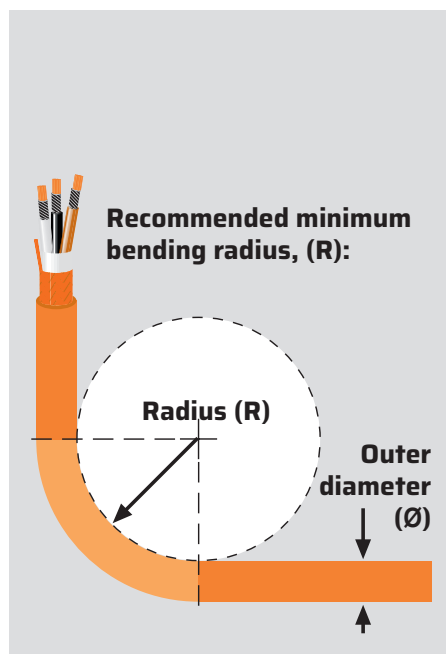

	LKM-ALU LKM-ALU-SHF2	During installation During installation	$R = 6 \times \emptyset$ $R = 9 \times \emptyset$	$< 25 \text{ mm}$ $> 25 \text{ mm}$
		Fixed installation Fixed installation	$R = 4 \times \emptyset$ $R = 6 \times \emptyset$	$< 25 \text{ mm}$ $> 25 \text{ mm}$
	LKSM-ALU LKSM-ALU-SHF2	During installation Fixed installation	$R = 9 \times \emptyset$ $R = 6 \times \emptyset$	
	LKSM-EMC-ALU LKSM-EMC-ALU-SHF2 LKSM-VFD-ALU LKSM-VFD-ALU-SHF2	During installation Fixed installation	$R = 12 \times \emptyset$ $R = 8 \times \emptyset$	

## DIAMETER TOLERANCE

Nominal outer diameter, mm.	Tolerance	Nominal outer diameter, mm.	Tolerance
1 - 10	$\pm 0.5 \text{ mm}$	30.1 - 40	$\pm 2.0 \text{ mm}$
10.1 - 20	$\pm 1.0 \text{ mm}$	40.1 - 50	$\pm 2.5 \text{ mm}$
20.1 - 30	$\pm 1.5 \text{ mm}$	50.1 - 60	$\pm 3.0 \text{ mm}$

## CORE IDENTIFICATION

0.6/1 kV	Normal type	G-type (with earth conductor)	1.8/3 kV	LKSM-VFD
1-core			1-core	
2-cores			3-cores	
3-cores			3-cores + 3-ground cores	
4-cores				
5-cores				
7-cores and above	 Black numbers on white base	 Black numbers on white base Last core yellow/green.		

BU = Blue, BN = Brown, BK = Black, GY = Grey, Y/G = Yellow/Green

Subject to change without prior notice. See latest update on our webpage.

© 2022 Helkama Bica Oy. All rights reserved.

## CURRENT RATING

Current rating (A) at an ambient temperature of 45 °C according to DNV rules Part4 Chapter8 Section2 Table7.

Current carrying capacities in continuous service at maximum rated conductor temperature of 90 °C.

### FOR CONTINUOUS SERVICE

Continuous service for a cable is to be considered as a current-carrying service (with constant load) having a duration longer than three times the thermal time constant of the cable, i.e. longer than the critical duration (see short time duty).

If more than 6 single core are bunched, without spacing for free air, correction factor 0,85 shall be used, provided free air circulation around the cable bunch. In other cases IEC 60092352 Annex A to be used.

### FOR ALUMINIUM CONDUCTOR CABLES

Number of conductors					
Size	1	2	3	4	5
35 mm <sup>2</sup>	119	102	83	83	69
50 mm <sup>2</sup>	149	127	104	104	86
70 mm <sup>2</sup>	184	157	128	128	107
95 mm <sup>2</sup>	223	189	156	156	129
120 mm <sup>2</sup>	258	219	189	180	150
150 mm <sup>2</sup>	296	252	207	207	172
185 mm <sup>2</sup>	337	287	236	236	195

### Correction factors for ambient temperature

Ambient temperature	35 °C	40 °C	45 °C	50 °C	55 °C	60 °C	65 °C	70 °C	75 °C	80 °C
Correction factor	1.10	1.05	1.00	0.94	0.88	0.82	0.74	0.64	0.58	0.47

## VOLTAGE DROP

Cables with Aluminium conductor(s). Resistance according to IEC 60228 Alu/class2

Size	Resistance at 20 °C ohm/km	Resistance at 90 °C ohm/km	Voltage reduction at 90 °C V/m	Resistance at 45 °C ohm/km	Current rating at 45 °C A	Voltage reduction at 45 °C V/Am
35 mm <sup>2</sup>	0.868	1.113	2.23	0.955	119	0.23
50 mm <sup>2</sup>	0.641	0.822	1.644	0.706	149	0.21
70 mm <sup>2</sup>	0.443	0.568	1.136	0.488	184	0.18
95 mm <sup>2</sup>	0.32	0.410	0.821	0.352	223	0.16
120 mm <sup>2</sup>	0.253	0.324	0.649	0.278	258	0.14
150 mm <sup>2</sup>	0.206	0.264	0.528	0.227	296	0.13
185 mm <sup>2</sup>	0.164	0.210	0.421	0.1805	337	0.12

## SHORT CIRCUIT CURRENT

Maximum permissible short circuit current.  
0.6/1 kV and 1,8/3kV 90 °C marine cables.

Based on formula:

$$I_k = 148 \times \frac{S}{\sqrt{t}} \times \sqrt{\ln \frac{234 + T_k}{234 + T_b}}$$

Formula 1:

$$I_k = 94 \times \frac{S}{\sqrt{t}}$$

Cross-section of conductor in mm <sup>2</sup>	Duration of short circuit in s.					
	0.2	0.5	1	2	3	10
35	7.4	4.7	3.3	2.3	1.9	1.0
50	10.5	6.6	4.7	3.3	2.7	1.5
70	14.7	9.3	6.6	4.7	3.8	2.1
95	20.0	12.6	8.9	6.3	5.2	2.8
120	25.2	16.0	11.3	8.0	6.5	3.6
150	31.5	19.9	14.1	10.0	8.1	4.5
185	38.9	24.6	17.4	12.3	10.0	5.5

Short circuit current in kA

- I<sub>k</sub>** = Maximum permissible short circuit current.
- S** = Cross-section of the conductor in mm<sup>2</sup>.
- t** = Duration of the short circuit in s.
- T<sub>k</sub>** = Maximum rated conductor temperature,
- T<sub>b</sub>** = Maximum rated conductor temperature, normal, °C

Formula 1: For 0.6/1 kV and 1,8/3kV cable with XLPE with maximum operating temperature of 90 °C (T<sub>b</sub>) and short circuit temperature of 250 °C (T<sub>k</sub>).

## SHORT CIRCUIT FACTOR

Short Circuit Factor can be calculated by following formula:

$$\text{SHORT CIRCUIT FACTOR} = \frac{\text{SHORT CIRCUIT CURRENT}}{\text{CURRENT RATING}}$$

## RATED VOLTAGES

Designating the of the rated voltages of cables are **U<sub>0</sub>/U (U<sub>m</sub>)**, where

**U<sub>0</sub>** is the rated power-frequency voltage between phase conductor and earth or metallic screen, for which the cable is designed.

**U** is the rated power-frequency voltage between phase conductors for which the cable is designed.

**U<sub>m</sub>** is the maximum value of the “highest system voltage” for which the cable may be used.

**DC** For 0,6/1kV cables, the DC voltages, maximum of 1.5 times the AC voltage may be provided so that the voltage to earth does not exceed U<sub>ODC</sub>.

Cable voltage	AC			DC	
	U <sub>0</sub>	U	U <sub>m</sub>	U	U <sub>ODC</sub>
0.6/1 kV	0.6 kV	1.0 kV	1.2 kV	1.5 kV	0.9 kV
1.8/3 kV	1.8 kV	3.0 kV	3.6 kV	3.0 kV	1.8 kV

## SHORT TIME DUTY

Short time duty according to the standard IEC 60092-352 0.6/1 kV 90 °C marine cables.

If a cable is intended to supply motor or equipment operating for periods of half an hour or one hour, its current rating given in table "current rating", may be increased using the relevant correction factors given by formula:

$$\text{correction factor} = \sqrt{\frac{1,2}{1-\exp(-t_s/T)}}$$

( $t_s$  = service time, min.  
 $T$  = Time constant, min.)

$T = 0.245 \times \varnothing^{1.35}$   
 ( $\varnothing$  = Overall diameter of the cable, mm.)

Ø of the cable, mm.	Service time		T, Time constant, min.	3 x T Critical duration, min.
	30 min.	60 min.		
1	1.058	1.058	0.245	0.735
2	1.058	1.058	0.625	1.87
3	1.058	1.058	1.08	3.24
4	1.058	1.058	1.59	4.78
5	1.058	1.058	2.15	6.46
6	1.058	1.058	2.75	8.26
7	1.058	1.058	3.39	10.2
8	1.059	1.058	4.06	12.2
9	1.059	1.058	4.76	14.3
10	1.061	1.058	5.48	16.5
20	1.126	1.066	14.0	41.9
30	1.255	1.105	24.2	72.5
40	1.403	1.173	35.6	107
50	1.554	1.254	48.2	145
60	1.705	1.341	61.6	185

Correction factor.

## INTERMITTENT SERVICE

Correction factor for intermittent service according to the standard IEC 60092-352

The correction factor given hereby has been roughly calculated for periods of 10 min, of which 4 min are with constant load and 6 min without load.

Intermittence period = 10 min.  
 Intermittence ratio = 40%.

$$F_i = \sqrt{\frac{1-\exp(-10/T)}{1-\exp(-4/T)}}$$

Ø of the cable, mm.	Correction factor.
1	1.000
2	1.001
3	1.012
4	1.042
5	1.083
6	1.127
7	1.170
8	1.208
9	1.242
10	1.273
20	1.433
30	1.490
40	1.518
50	1.534
60	1.544





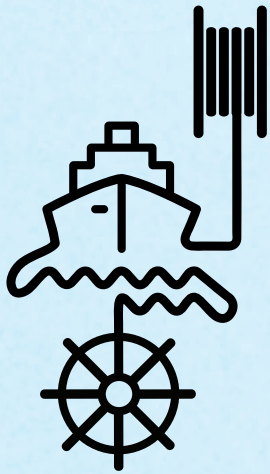

## **HELKAMA BICA OY**

Lakimiehenkatu 4  
FI-20780 KAARINA, FINLAND  
(Turku area)

Lasitehtaankatu 12  
FI-10960 HANKO, FINLAND

Tel. +358 2 410 8700

[customer.care@helkamabica.fi](mailto:customer.care@helkamabica.fi)

[helkamabica.com](http://helkamabica.com)

## **HELKAMA BICA (Shanghai) Co., Ltd.**

Plot 1-2, Minghang EPZ  
No. 3111 Huan Cheng  
West Road  
Fengxian Distr.  
Shanghai 201401, China

Tel. +86 21 3365 5333

[sales@helkamabica.cn](mailto:sales@helkamabica.cn)



**2022**

**HELKAMA**  
THE PERFECT CONNECTION